

Approach to energy industry

● Rotor

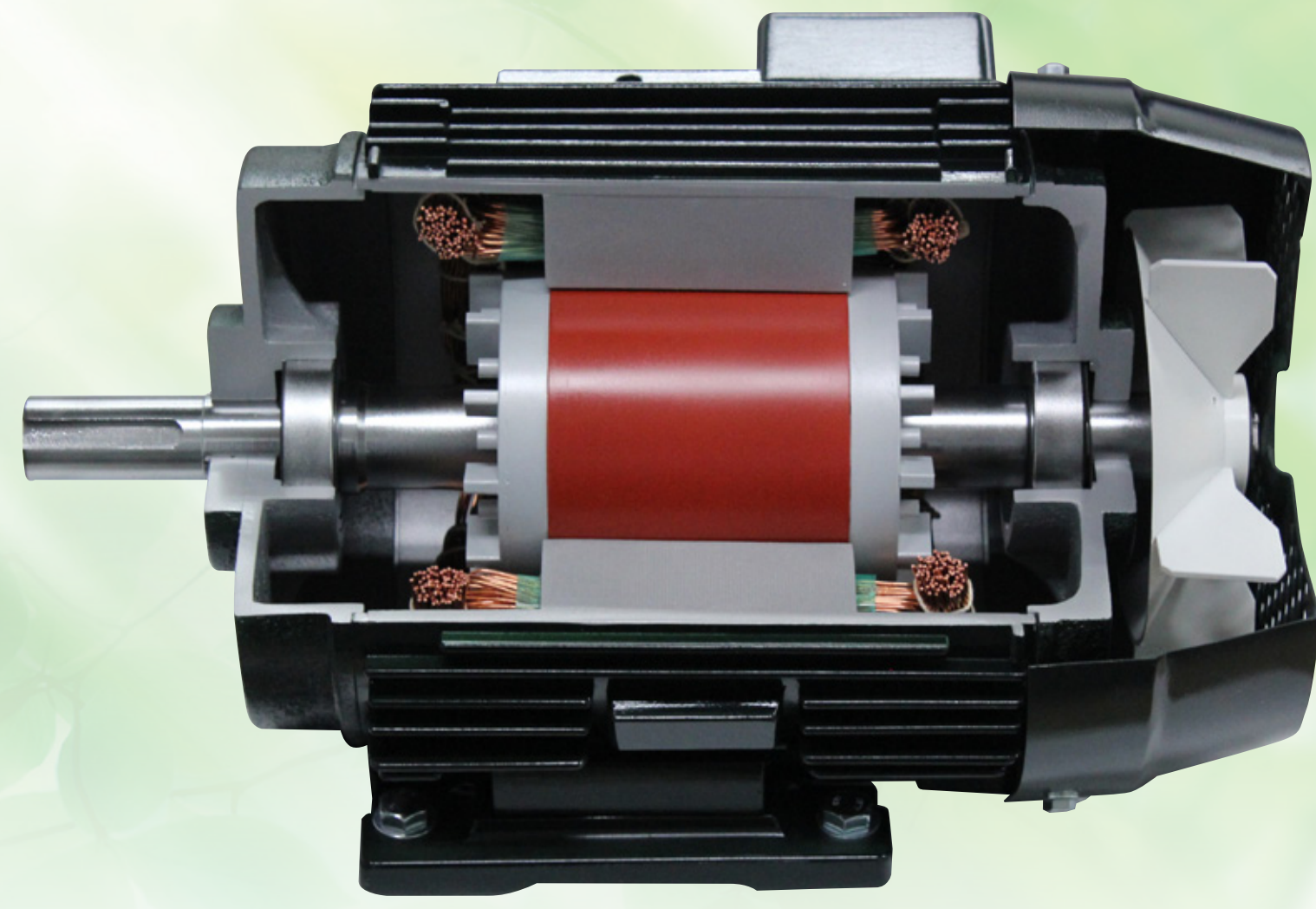

An image offer: TOSHIBA INDUSTRIAL PRODUCTS and SYSTEMS CORPORATION

- Separator film for Lithium-ion secondary battery
- Backsheet and sealing material for Solar cells

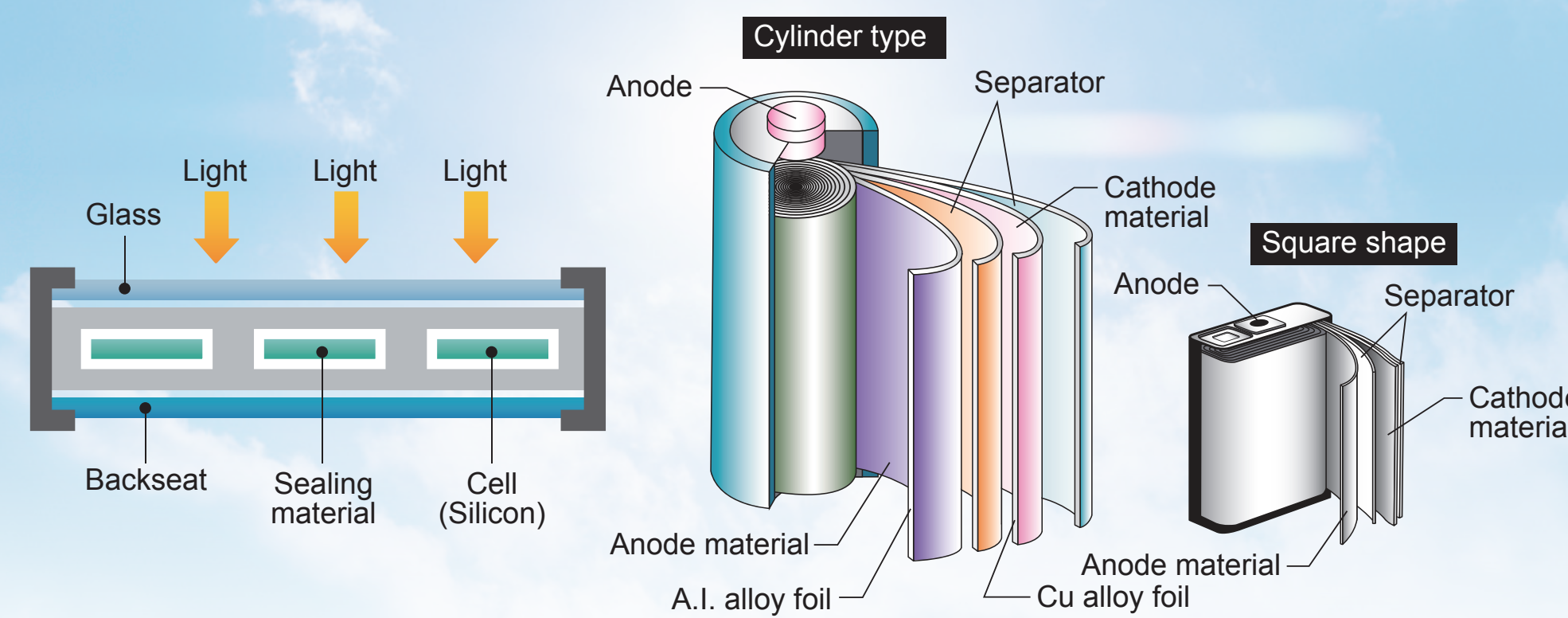

▲ Fresnel Lens for Photovoltaic Power Generation

● Mold for Fresnel Lens

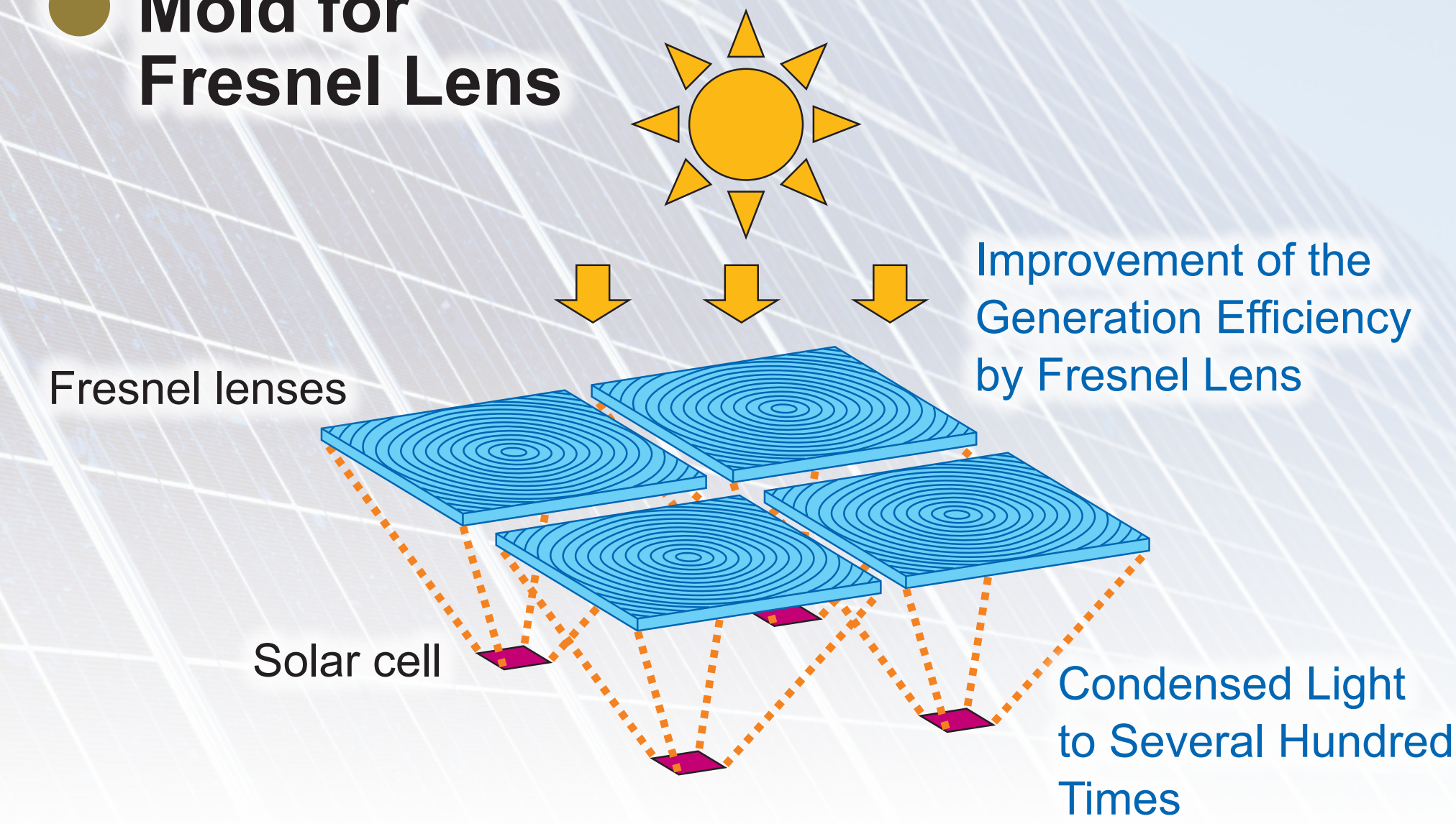

● Recycled paper production machine

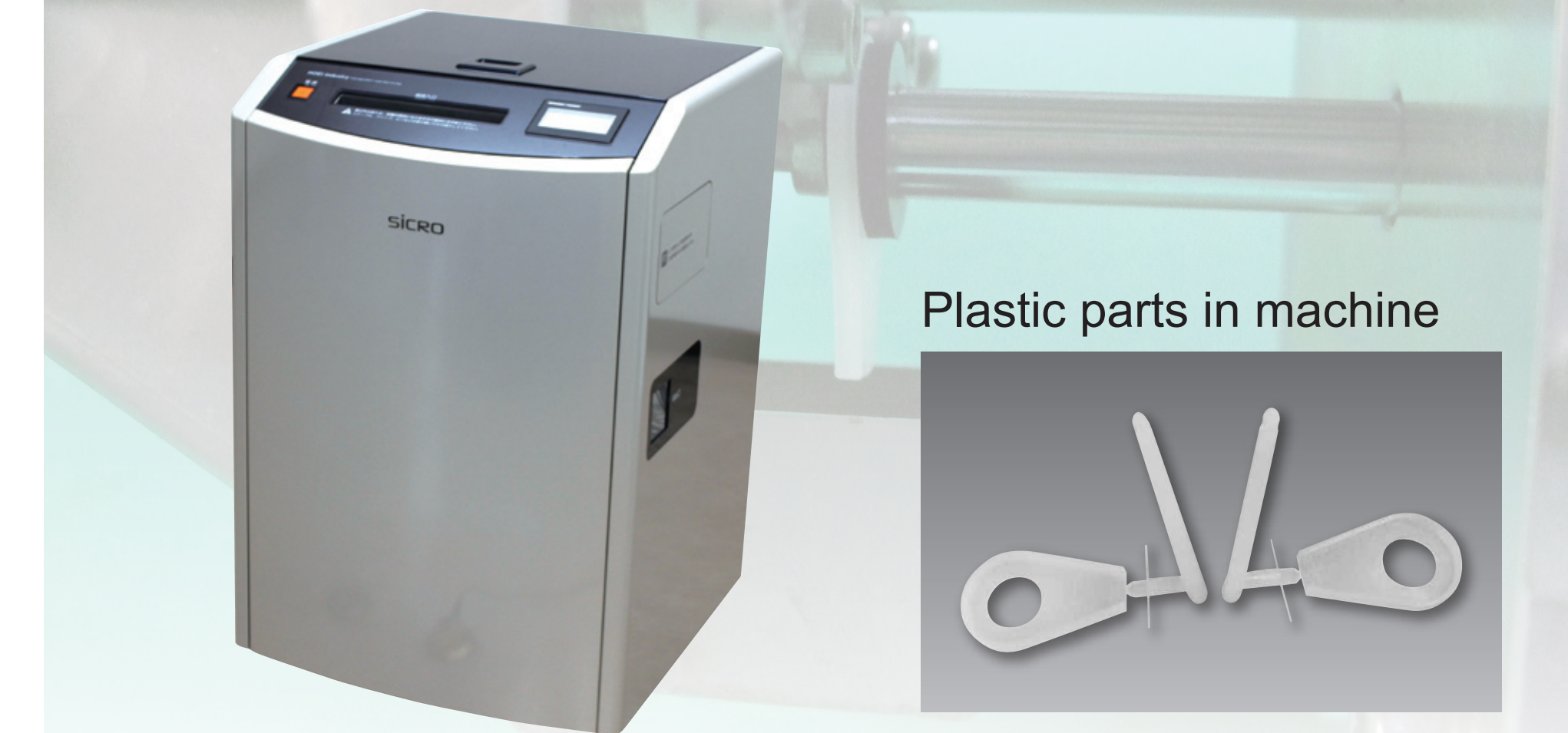

Offered by HOEI Industry Co. Ltd.

- For rotor blade, rotor hub
- For gear of the pitch, yaw
- For frame of the pitch, yaw

- For tube plate of the heat exchanger, boiler
- ▲ For rotation part of the wind mill

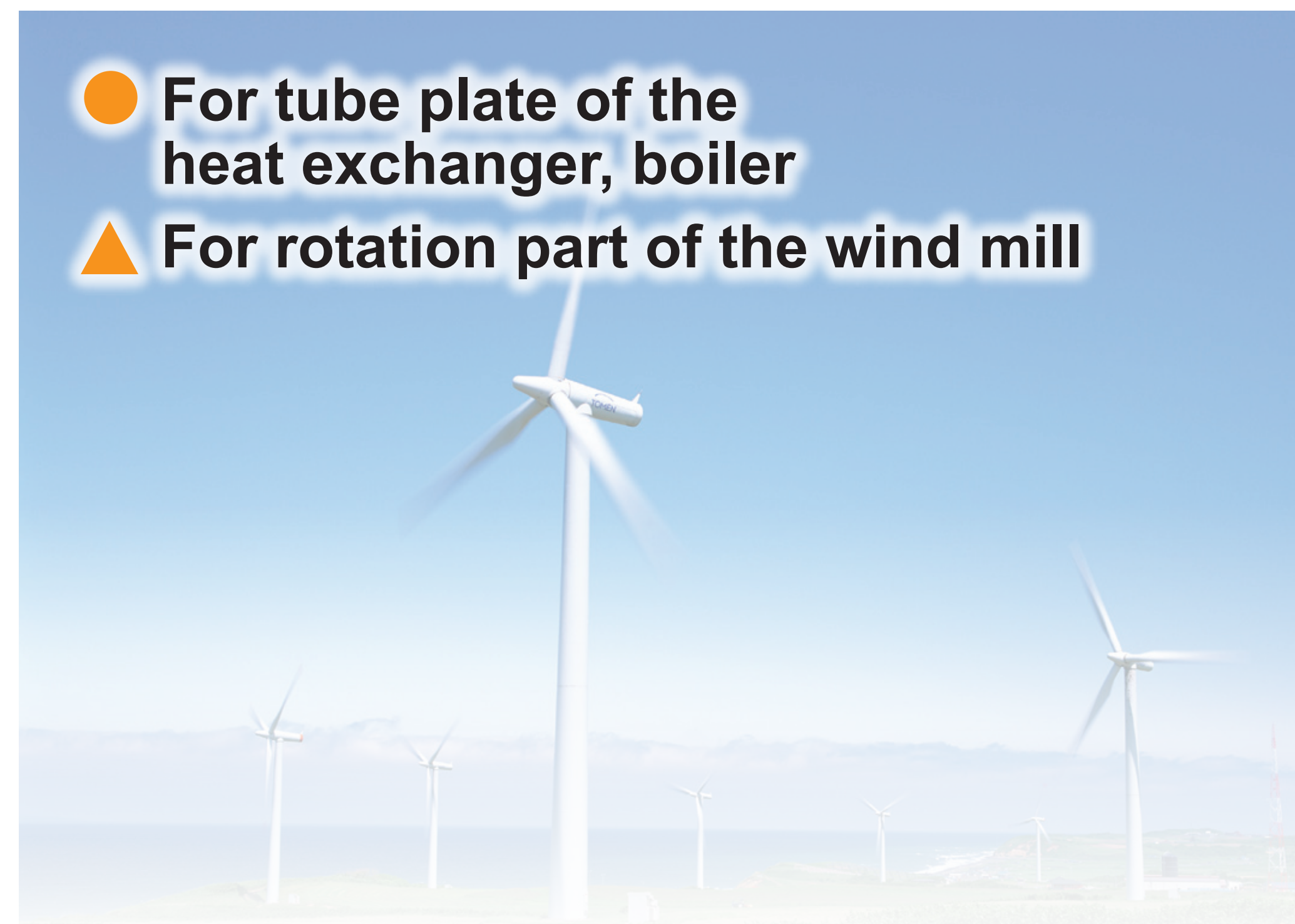
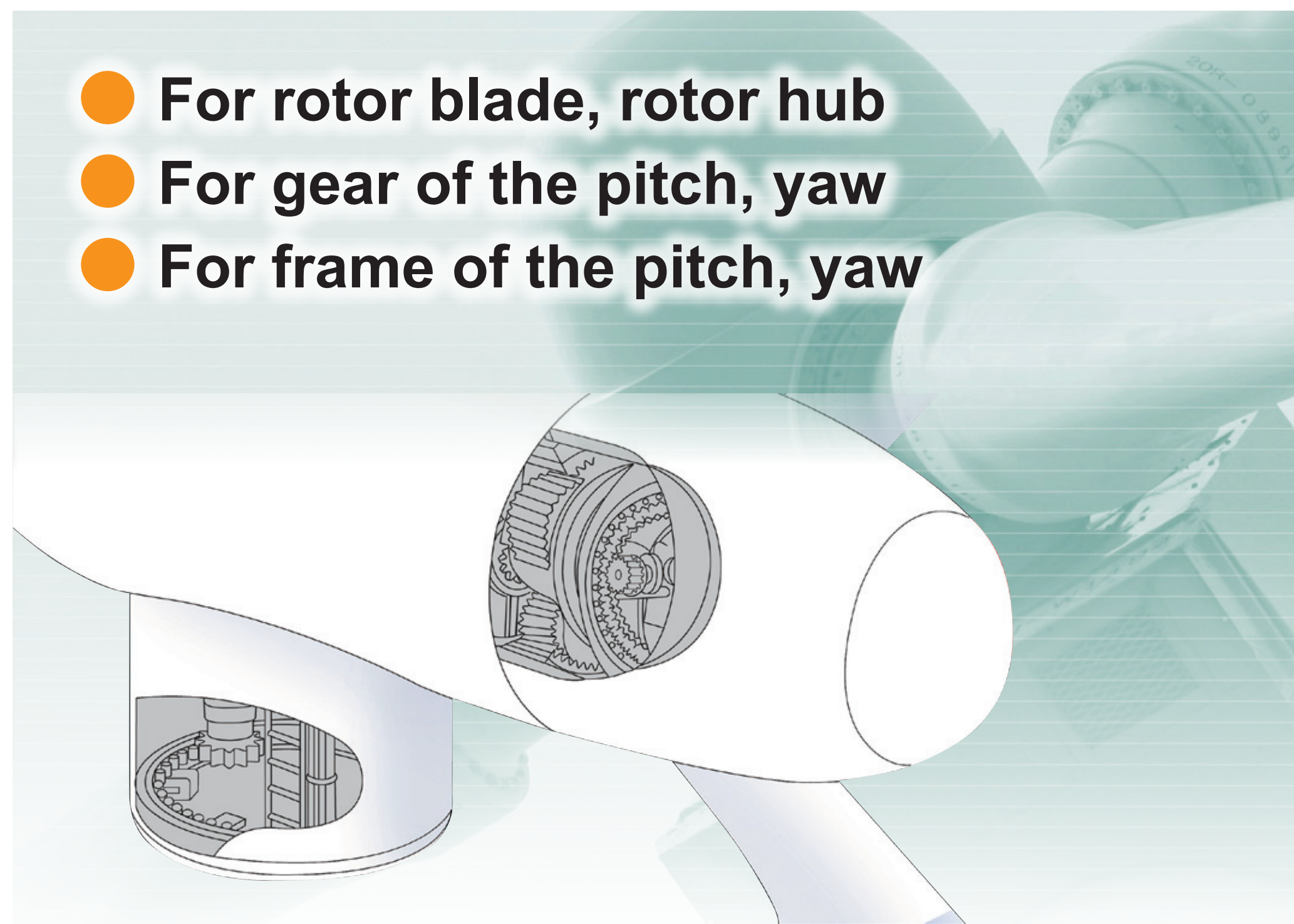

■ Inverter-Controlled Engine Generator System

Image courtesy of Hokuetsu Industries Co., Ltd.

Toshiba-Machine-developed unit embedded (operation side view)

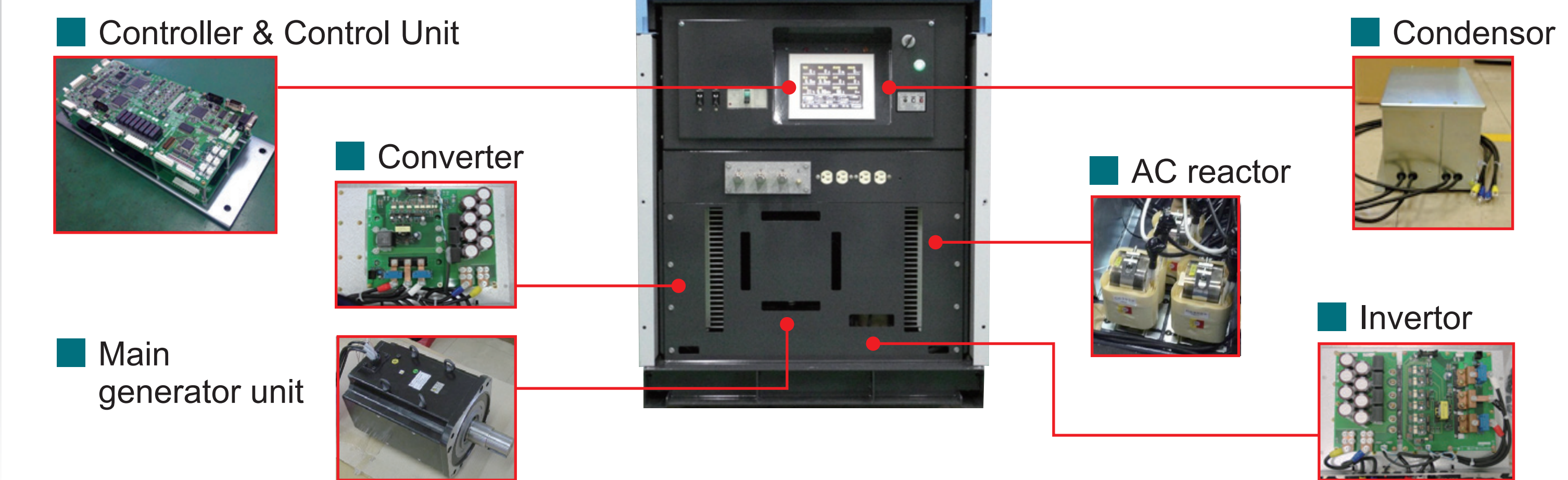

VS Generator (VSG28A)
Awarded ten best new products of the year prize by Nikkan Kogyo Shinbun along with Hokuetsu Industries Co., Ltd. and Toshiba Industrial Products and Systems Corporation

LINEUP

Injection Molding Machines

- Die locking force: 20~350t Injection Molding Machines
- ▲ Die locking force: 450~1300t Injection Molding Machines



Die Casting Machines

- Die locking force: 135~500t Die Casting Machines



Extrusion Machines

- Sheet·Film Manufacturing Equipment

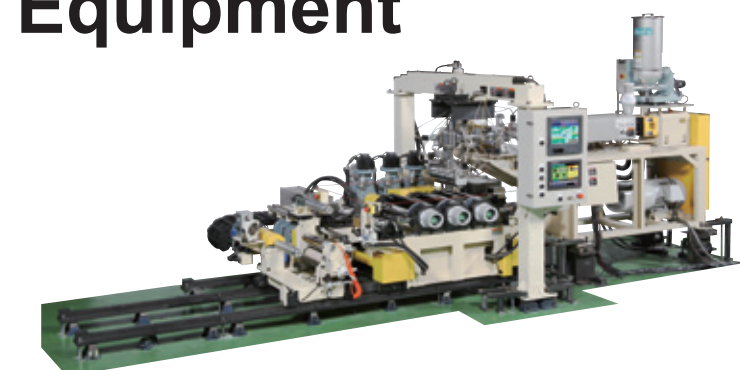

Machine Tools

- Gear Hobbling Machines
- Gantry type machining center
- ▲ Drilling machine for rotation part



High Precision Machine· Glass Mold Press Machine

- High Precision Vertical Machines



Electronic Controls

- Vertical Articulated Robot
- Inverter-Controlled Engine Generator System



SHIBAURA SEMTEK CO., LTD.

- Investigation of manufacturing parts
- Strength testing
- Fracture analysis
- Analysis of organic and inorganic material
- Investigation of environment
- Measurement of wastewater and exhaust gas
- Measurement of low-frequency noise